



PRODUCT CATALOGUE 2026

**WHERE COMPASSION
MEETS CRAFTSMANSHIP.**

FIRST CALL

PREPARATION

FUNERAL



Our Mission

To put heroes first by delivering innovative, high-quality products that can be relied on around the world.

Our Vision

To be the worlds leading expert for mortuary, emergency and rescue product solutions that heroes trust most.

Our Expertise

For 70 years Ferno Mortuary has delivered outstanding quality products to help make life easier for mortuary professionals, while respecting the life of those entrusted to you.

Contents

FIRST CALL 4-17

iNX Powered Stretcher & Loading	4
24-MiniMAXX® Mortuary Cot	6
24-MAXX Mortuary Cot	7
Model 24 Multi-Level Cot	8
Model 27-1 Multi-Level Cot	9
Model 23 Roll-In Style Cot	10
Mini Cot Roll-In Style Cot	11
Model 372 Cot Mattress	12
Model 375 Tapered Cot Mattress	12
24-MAXX® Cot Mattress	12
24-MiniMAXX® Cot Mattress	12
Model 414-OL Over-The-Lap-Restraints	13
Model 414-R Wrist Restraints - Cot Sidearm	13
Model 414-AR Ankle Restraints	13
Model 430 Two-Piece Restraints	13
Model 5 Mortuary Fastener	14
Model 533 Wheel Cups	14
Model 534/535 Post Cups	14
Model 132 Manta™ Retrieval Aid	14
Model 65 Scoop™ Stretcher	15
Model 65EXL Scoop™ Stretcher	15
Ferno Transfer Board	15
Beasy Trans™ Transfer Board	15
Model 11 Stretcher with Wheels	16
Model 135 Stretcher/Body Bag	17
Model 131 Flexible Stretcher	17
Model 338 Disaster Pouch	17
Model 347-1 Disposable Pouch	17
24-MAXX® First Call Cover	18
Model 320 First Call Cover	18

Model 321 First Call Cover	18
Model 325 First Call Cover	18
Model 330 First Call Cover	18
Model 335 First Call Pouch	19
24-MAXX® First Call Pouch	19
24-MiniMAXX® First Call Pouch	19
Crypton® Fabrics	19

PREPARATION 18-23

Model 101-H Hydraulic Operating Table	20
Model 102 Folding Operating Table	22
Model 103 Combination Operating Table	23
Model 34 Folding Dressing Table	24
Model 36 Dressing Table	25

FUNERAL 24-29

Cemetery Church Truck	26
Model 87 Church Truck	27
Model 88 Church Truck	27
Model 87-F Drape Frame Attachments	28
Model 87-D Drapes	28
Model 401/402 Church Truck Covers	28
Model 110 Showroom Truck	29
Model 112 Showroom Truck	30
Model 124 Adjustable Casket Table	31
Model 570 Series Bier Pins	31
Tailgate Roller Assemblies	31
Policies & Disclaimers	32
Index	33

70 Years Delivering Excellence

Ferno is extremely proud to have been supporting patients, operators and organizations in the mortuary industry since 1955, from the early innovations of the worlds first one-person mortuary cot, to the groundbreaking powered mortuary cots to make life easier for professionals today.

We understand the mortuary industry, locally and around the world. Through ourselves and our global partners we aim to learn, to develop and to improve - all with the aim of better supporting those working in the mortuary industry, and the patients it supports.

Our unwavering commitment to building high quality products is the same today as it was in 1955. We're extremely proud of our legacy for solutions that can last decades, and we'll continue to work tirelessly to ensure this reputation for reliability and trust continues, for life.

iNX[®] Powered Stretcher & Loading System



Product Overview

The iNX Integrated Patient Transport & Loading System is designed to enhance operator safety by effectively eliminating lifting. Now you can lift, lower, load and unload with the push of a button, taking the strain off your back.



Dual, powered actuators maximise tip stability and lift loads up to 700 lb.

Simple one-touch operation helps you stay focused on the task at hand.

Telescoping load frame maximises manoeuvrability in tight spaces.

Sealed memory foam mattress

SAE J3027 compliant when the iNX is fastened with the iNLINE fastening system.

Integrated Charging System eliminates the need for battery management. Auto-shut off when the iNX is docked prevents accidental operation in-vehicle.

Integrated Loading System enables you to stop lifting and to load and unload at the push of a button

Specifications

	Length Max	Length Min	Weight	Weight Capacity	Power
iNX	81" (2057 mm)	63" (1600 mm)	203 lb (92 kg)	700 lb (318 kg)	36 Volt



iNLINE Fastening System

The iNLINE Fastening System meets SAE J3027 and exceeds worldwide standards.

Available in varying lengths to suit differing vehicle sizes, the iNLINE Fastening System glides the iNX into position when loading and unloading. Its design allows for extreme loading and unloading approach angles.

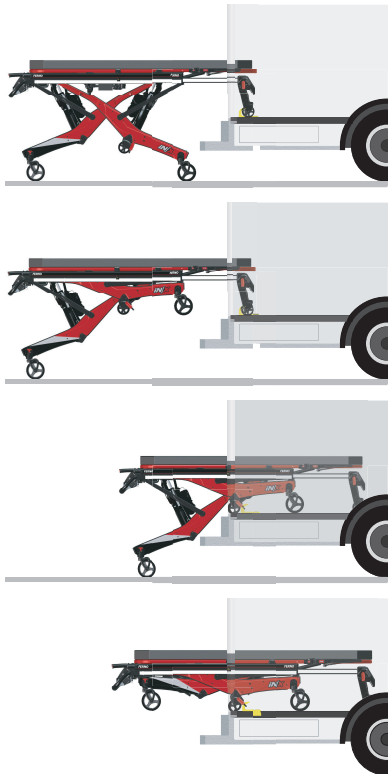

SX Surface Xtender FWESX

The SX Surface Xtender increases the width of the stretcher surface to accommodate larger body shapes.

It features five adjustable locked positions plus an unlocked, lowered position that allows the SX to be positioned out of the way for transfer of the deceased and does not interfere with loading and unloading. Injection moulded with smooth, clean lines for easy cleaning.



Reducing Risk, Injury & Cost

In 2025, the US Occupational Safety and Health Administration estimated the direct cost to an employer for an employees strain injury was \$67,000.

Coupled with the ever increasing adult obesity rate, mortuary professionals are at growing risk of injury. whilst mortuary organizations themselves are at risk of having to pay considerable insurance and compensation costs for injuries to mortuary professionals.

With powered mortuary cots, mortuary organizations can alleviate the financial risk thanks to reducing the risk of strain injuries, relying on the technology to lift patients, not employees.

Product
 BASE MODEL
 iNX w/ SX SHIP KIT
 86" INLINE FASTENER
 95" INLINE FASTENER
 102" INLINE FASTENER

SKU
 0000iNXiNlINDWL
 0000iNXiNlINSX
 ILFS86
 ILFM95
 ILFL102

24-MiniMAXX® Mortuary Cot



Features & Accessories



Optional Rolling Wheel Kit
080-0555



Side-Lift Handles (Pair)
0821998



Sidearms
0821997



Replacement Mattress
0314042



Cover
0314154

Product Overview

The 24-MiniMAXX has all of the innovative features of the 24-MAXX in a narrow package. Able to handle large bodies with ease. The narrow bed surface provides increased maneuverability and allows two cots to be placed side-by-side in the rear of most vehicles. Comes complete with a 1-inch mattress and two seven-foot, two-piece black restraints, and is compatible with most Ferno covers and pouches. The 24H-MiniMAXX includes all the great features of the 24-MiniMAXX and is specially designed for high-floor vehicles.

Key Features

- True independent legs with multi-level adjustment
- 1000 lb capacity
- Six-inch wheels
- Dual hand controls
- Distinguished durable gloss-black powder-coated finish

Product

- 24-MiniMAXX
- 24H-MiniMAXX
- 24-MiniMAXX with Sidearms Installed
- 24H-MiniMAXX with Sidearms Installed
- 24-MiniMAXX with Side-Lift Handles Installed
- 24H-MiniMAXX with Side-Lift Handles Installed

SKU

- 0032501
- 0032504
- 0032502
- 0032505
- 0032503
- 0032506

Specifications

	Length	Width	Height Max.	Height Min.	Weight	Load Limit	Loading Height
24-MiniMAXX	76" (193 cm)	23.625" (60 cm)	40" (100 cm)	14" (35 cm)	76 lb (34 kg)	1000 lb (454 kg)	26" (66 cm)
24H-MiniMAXX	76" (193 cm)	23.625" (60 cm)	40" (100 cm)	14" (35 cm)	76 lb (34 kg)	1000 lb (454 kg)	32" (81 cm)

24-MAXX® Mortuary Cot



Features & Accessories



Optional Rolling Wheel Kit
080-0555



Side-Lift Handles (Pair)
0821998



Sidearms
0821997



Replacement Mattress
0314042



Cover
0314154

Product Overview

The 24-MAXX allows you to transport bodies weighing up to 1000 pounds while reducing the risk of back injuries. The cot allows easy maneuverability in tight areas and down stairs, and has a powder-coated frame and stylish design. The 24-MAXX, with a variety of innovative features combined with highly dependable performance.

Key Features

- Independent leg design
- Oversized wheels
- Two seven-foot, two-piece black restraints

Product

- 24-MAXX
- 24-MAXX with Sidearms Installed
- 24-MAXX with Side-Lift Handles Installed (1 pair)

SKU

- 0032498
- 0032500
- 0032499

Specifications

	Length	Width	Height Max.	Height Min.	Weight	Load Limit	Loading Height
24-MAXX	76" (193 cm)	26" (66 cm)	40" (102 cm)	14" (35 cm)	78 lb (35 kg)	1000 lb (454 kg)	26" (66 cm)

Model 24 Multi-Level Cot



Features & Accessories



2-Piece Restraints
0313892



Sidearms



Side-Lift Handles (Pair)
0821998



Telescoping Handles
0087150

Product Overview

The Model 24 Multi-Level, Roll-In Style Cot allows one person to perform retrieval without assuming the full weight of the cot and body. In confined areas, acts as a highly maneuverable, two-wheeled stretcher when the undercarriage is folded and locked.

Key Features

- Special release levers to raise and lower effortlessly
- Loading End Legs unfold and lock automatically
- Built-in stair glides
- Multi-level feature for easy moving from bed to cot
- Cot designed to be a portable stretcher

Product

Model 24 Mortuary Cot	0032400
Model 24 Mortuary Cot with Sidearms	0032410
Model 24 Mortuary Cot with Wheel Locks (2)	0032450
Model 24 Mortuary Cot with Sidearms, Wheel Locks (2)	0032487

The Model 24-H includes all the great features of the Model 24 and is specially designed for high-floor vehicles.

Model 24-H Mortuary Cot	0032420
Model 24-H Mortuary Cot with Sidearms	0032490
Model 24-H Mortuary Cot with Wheel Locks (2)	0032488
Model 24-H Mortuary Cot with Sidearms, Wheel Locks (2)	0032486
Model 372 Mattress	0311360

Specifications

	Length	Width	Height Max.	Height Min.	Weight	Load Limit	Loading Height
Model 24	77" (193 cm)	21" (53 cm)	32" (82 cm)	10" (24 cm)	51 lb (24.5 kg)	400 lb (181 kg)	26" (61 cm)
Model 24-H	76" (193 cm)	21" (53 cm)	33" (84 cm)	10" (24 cm)	54 lb (24.5 kg)	400 lb (181 kg)	31" (79 cm)

Model 27-1 Multi-Level Cot



Features & Accessories



Swivel Wheels



Sidearms



2-Piece Restraints
0313892



Side-Lift Handles (Pair)
0821998

Product Overview

The Model 27-1 Multi-Level, Roll-In Style Cot blends classic design with innovative features. Easy to maneuver in close quarters and narrow doorways and allowing easy access to the body. The multi-level undercarriage provides flexibility in retrieval. Comes with a burgundy, Model 375 one-inch mattress and two Model 430 five-foot-long, two-piece black quick-release restraining straps.

Key Features

- All four wheels swivel
- Folding end-section on cot shortens cot by 9"
- Tapered head section for tight corners
- Loading-end wheels lock as necessary
- Available sidearms

Product

- 27-1 First Call Cot
- 27-1 First Call Cot with Sidearms
- 27-1 Mattress

SKU

- 0032485
- 0032484
- 0313059

SPECIFICATIONS

	Length	Width	Height Max.	Height Min.	Weight	Load Limit	Loading Height
Model 27-1	78¾" (200 cm)	24" (61 cm)	34" (86 cm)	10" (25 cm)	62 lb (28 kg)	400 lb (181 kg)	25" (64 cm)

Model 23 Roll-In Style Cot



Features & Accessories



2-Piece Restraints
0313892



Sidearms



Side-Lift Handles (Pair)
0821998



Telescoping Handles
0087150

Product Overview

With an extra-long wheel base to provide exceptional stability, its slide-action leg lock securely locks both sets of legs simultaneously when folded. Its legs fold and lock, while it can also be used as a two-wheeled stretcher. Stair glides reduce wear on the cot and promote smooth movement down stairs. The cot is also wide enough to accommodate a portable stretcher. Comes complete with a Ferno Model 372 one-inch burgundy mattress and two Model 430 five-foot-long, two-piece, black quick-release restraint straps. Other accessories are available.

Key Features

- Extra long wheel base for stability
- Slide action leg lock
- Can be used as two-wheeled stretcher
- Stair glides reduce wear and tear

Product

Model 23 Mortuary Cot
Model 23 Mortuary Cot with Sidearms
Model 372 Mattress

SKU

0032300
0032489
0311360

Specifications

	Length	Width	Height Max.	Height Min.	Weight	Load Limit	Loading Height
Model 23	76" (192 cm)	21" (53 cm)	32" (80 cm)	10" (24 cm)	44 lb (20 kg)	400 lb (181 kg)	26" (66 cm)

Mini Cot Roll-In Style Cot



Features & Accessories



Independent Legs



Cover
0314158

Product Overview

Compact and lightweight, designed for pet removal or small body retrieval. Its One-Man®, roll-in style allows one person to perform retrieval and has extendable loading wheels for easy loading and unloading. Special release levers make it possible to raise and lower the cot without assuming the full weight of the cot and body. Two 5' Model 430-P restraints are included.

Key Features

- Compact and lightweight
- Designed for pet or small body retrieval
- Allows for one-person retrieval
- Extendable loading wheels for easy loading and unloading

Product
Mini Cot

SKU
0403026

Specifications

	Length	Width	Height Max.	Height Min.	Weight	Load Limit	Loading Height
Mini Cot	55½" (141 cm)	22" (56 cm)	29½" (75 cm)	9" (23 cm)	63 lb (28.5 kg)	300 lb (136 kg)	23½" (60 cm)



Model 372 Cot Mattress

The Model 372 Cot Mattress is constructed with a one-inch polyurethane, foam pad covered with vinyl-coated nylon. The cover is wear and abrasion-resistant, bacteriostatic, fire-resistant, and easy to clean. Available in burgundy. Fits model 24 and 23 cots.

Measures 72" x 18" x 1" (182 x 46 x 3 cm)	Product Model 372 Cot Mattress	SKU 0311360
---	-----------------------------------	----------------



Model 375 Tapered Cot Mattress

The Model 375 Tapered Cot Mattress is constructed with a one-inch polyurethane, foam pad cover with vinyl-coated nylon. The cover is wear and abrasion-resistant, bacteriostatic, fire-resistant, and easy to clean. Available in burgundy. Fits the Model 27-1 First Call Cot.

Measures 72" x 19" x 1" (182 x 48 x 3 cm)	Product Model 375 Tapered Cot Mattress	SKU 0313059
---	---	----------------



24-MAXX® & 24-MiniMAXX® Mattresses

These mattresses are constructed with a one-inch polyurethane, foam pad cover with vinyl-coated nylon. The cover is wear and abrasion-resistant, bacteriostatic, fire-resistant, and easy to clean. Available in black.

24-MAXX Mattress Measures 71" x 24" x 1" (180 x 61 x 3 cm)	Product 24-MAXX Mattress	SKU 0313998
24-MiniMAXX Mattress Measures 70" x 21" x 1" (178 x 55 x 3 cm)	24-MiniMAXX Mattress	0314042

Model 414-OL Over-The-Lap Restraints

Over-The-Lap Wrist Restraints fasten to both sides of the cot frame and hold the patient's wrists on the lap. Each side is adjustable so the patient's wrists can be centered over the midline of the body. Wrists are secured independently by hook-and-loop closures. Made of 2" nylon webbing and chrome-plated hardware. The main strap is 68" (173 cm), and the wrist straps are 15" (39 cm). Available in orange and burgundy.

Product
Model 414-OL Over-The-Lap Restraints, Orange

SKU
0312320



Model 414-R Wrist Restraints – Cot Sidearm

When fastened to the side frame, this restraint holds the patient's wrist securely to the top of the side frame. Made of 2" wide nylon webbing, the restraints come as a pair in orange or burgundy.

Product
Model 414-R Wrist Restraints - Cot Sidearm, Orange

SKU
0312310



Model 414-AR Ankle Restraints

Ferno's Ankle Restraints fasten to both sides of the cot frame to hold the patient's ankles securely in place. Independent restraints allow each leg to be individually secured or released from the hook-and-loop closures. Constructed of 2" nylon webbing. Restraints are 41" (104 cm) long. Available in orange and burgundy.

Product
Model 415-AR Ankle Restraints, Orange

SKU
0312330



Model 430 Two-Piece Restraints

These restraints are made of 2" nylon webbing with quick-release, automotive type, chrome-plated metal buckles that resist rust and corrosion. Push-button operation allows secure fastening and easy release. Hemmed tab prevents strap from being pulled free of buckle. Available in black only. Available in either 5' or 7' lengths.

Product
Model 430, 5' Two-Piece Restraints, Black
Model 430, 7' Two-Piece Restraints, Black

SKU
0313892
0313911





Model 5 Mortuary Fastener

This fastener is permanently mounted to floor plates to secure cots and stretchers, including the Models 23, 24, 24H, 24-MAXX®, 24-MiniMAXX® and 27-1 Series. Thumbscrews permit easy installation and removal. The rear-fastener hook stores flat when not in use and rotates up to fasten as a ratchet mechanism when needed. Specify your stretcher model when ordering. Not for use in crash-stable applications.

Product SKU
 Model 5 Fastener 0565000



Model 533 Wheel Cups

Wheel cups inhibit stretcher movement within a vehicle. Polished aluminum wheel cups are available individually for 4" and 7" (wheelchair) wheels.

Product SKU
 Model 533, 4" Wheel Cups (each) 0815334



Model 534/535 Post Cups

Post cups hold stretcher posts firmly in place on the vehicle floor. Available in pairs only, these cups are permanently mounted.

Product SKU
 Model 534 Recessed Post Cups (pair) 0815340
 Model 535 Raised Post Cups (pair) 0815350



Model 132 Manta Retrieval Aid

This compact and easy-to-store retrieval aid is ideal for extracting bodies from confined areas. Eight reinforced hand-holds provide ample grasping points for removal personnel. Made of durable vinyl, the Manta can carry bodies weighing up to 800 lb.

Product SKU
 Model 132 Manta 0382969

SPECIFICATIONS

	Length Open	Width	Height	Folded	Weight	Load Limit
Manta	79" (200 cm)	46" (107 cm)	0.1" (1/4 cm)	12x9x3" (30.5x23x7.5 cm)	5 lb (2.2 kg)	800 lb (363kg)

Model 65 Scoop™ Stretcher

Designed to be uncoupled on either or both ends and gently scoop up the body using a scissor-type closing motion. All-aluminum construction is lightweight and durable. The 65 Scoop™ is adjustable lengthwise to accommodate various body sizes. Comes with three restraints.

Product SKU
Model 65 Scoop™ Stretcher 0000451

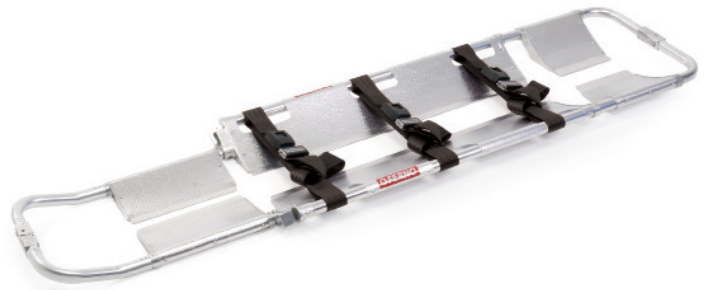

65 EXL Scoop™ Stretcher

The Scoop EXL Stretcher provides superior comfort and safety to patients in need of spinal immobilization. It eliminates the need for log-roll maneuvers, significantly decreasing movement to the patient's cervical spine and reducing the chance of further injury.

Product SKU
65 EXL Scoop Stretcher 00065EXLRED
65 EXL Scoop TSL Extenders 0832274



Ferno Transfer Board

Use the Ferno Transfer Board to transfer a patient between adjoining surfaces, such as a bed and a transport cot, or a transport cot and table. Weighing 4.5 lb, 45" long and 18" wide.

Product SKU
Transfer Board 0107992



Beasy Trans™ Transfer Board

The Ferno Beasy Trans Transfer Board provides a safe and efficient way to transfer a sitting patient between adjoining surfaces, such as a bed and a transport cot. The unique sit-and-glide system reduces the effort needed by providers to move the patient. Weighing 6.5 lb, can carry up to 400 lb, 40" long and 12" wide.

Product SKU
Beasy Trans™ Transfer Board 0779487



SPECIFICATIONS

	Length Open	Width	Height	Folded	Weight	Load Limit
Model 65	79" (201 cm)	17" (43 cm)	3.5" (9 cm)	47x17x4" (119x43x10 cm)	16 lb (7 kg)	350 lb (159 kg)
65 EXL Scoop	79" (201 cm)	17" (43 cm)	3" (7.625 cm)	47x17x3" (119x43x7.62 cm)	18 lb (8 kg)	500 lb (227 kg)



Model 11 Stretcher with Wheels

The Model 11 Stretcher is a simple, flat stretcher featuring a lightweight aluminum frame and a heavy-duty, bacteriostatic, vinyl-coated nylon cover. Exclusive slimline center hinges enable the stretcher to fold for compact storage. Includes two 5' quick-release patient restraints. For easy handling, Model 385-A Combination Storage and Carrying Case is available. The Model 11 comes in burgundy.

Product SKU
 Model 11 Stretcher 0101110



Model 385-A Stretcher Case

The Model 385-A is designed to carry or store the Model 11 Stretcher with Wheels. The Model 385-A comes in burgundy.

Product SKU
 Model 385-A Stretcher Carrying Case 0311640



Model 131 Flexible Stretcher

Constructed of 18-ounce nylon and solid oak slats, the flexible stretcher's heat-sealed seams protect the slats and reinforce the overall construction. Three 2" webbing straps secure the carrier around the body and the six handles make it easy to carry the body. Available in burgundy.

Product SKU
 Model 131 Flexible Stretcher 0310161

SPECIFICATIONS

	Length Open	Length Folded	Width Open	Height Open	Weight	Load Limit
Model 11	74" (187 cm)	37" (94 cm)	19" (47 cm)	8" (20 cm)	13 lb (6 kg)	350 lb (159 kg)
Model 131	74½" (189 cm)	NA	26½" (67 cm)	NA	16 lb (7.26 kg)	500 lb (227 kg)

Model 135 Stretcher/Body Bag

This combination flexible stretcher and body bag folds compactly and completely conceals the body. The two-ply, vinyl-coated nylon construction resists stain, does not absorb moisture or body fluids, is fire resistant, and is easily cleaned with a damp cloth. Features a full plastic zipper and six durable, permanently blocked formed handles. Available in burgundy.

Product
Model 135 Flexible Stretcher/Body Bag

SKU
0310180



Model 338 Disaster Pouch

Heavy-duty, vinyl-coated nylon fabric makes a sturdy pouch. This pouch features a full-length, brass zipper. Six strong, easy-to-grip carrying handles permit the pouch to be used as a litter. Available in burgundy.

Product
Model 338 Disaster Pouch

SKU
0311020



Model 347-1 Disposable Pouch

The disposable pouch is made of electronically sealed vinyl that resists abrasions, acid, formaldehyde and blood stains. Will not leak, deteriorate or mildew, and is not affected by temperature extremes. Available in white only.

Product
Model 347-1 Disposable Pouch, PEVA, Burnable

SKU
0314043



SPECIFICATIONS

	Length	Width	Height	Weight	Load Capacity
Model 131	74½" (189 cm)	26½" (67 cm)	NA	16 lb (7.26 kg)	500 lb (227 kg)
Combi 135	77" (196 cm)	27" (69 cm)	NA	17 lb (7.7 kg)	500 lb (227 kg)
Disaster 338	90" (321 cm)	36" (92 cm)	NA	NA	350 lb (159 kg)
Disposable 347-1	90" (321 cm)	36" (92 cm)	NA	NA	NA



24-MAXX® First Call Cover

The extra-large 24-MAXX First Call Cover is specially designed for large bodies. The 24-MAXX Cover fits the 24-MAXX, 24-MiniMAXX, Model 24 and Model 27-1 cots. It is only available in the Crypton® Aria fabric. Includes a 12" x 14" pocket.

Product	SKU
24-MAXX First Call Cover, Cabernet	0314154
24-MAXX First Call Cover, Black	0314155



Model 320 First Call Cover

The slip-over styling of this cover fits One-Man® Cots. Secured by elastic at both ends, the cover is reversible end-to-end. The cover fits cots approximately 76" x 20" (193 cm x 51 cm), which includes the Model 24 series and Model 27-1 series cots. It is available in the Crypton® Aria or Suede. Includes a 12" x 14" pocket.

Suede	SKU	Aria	SKU
Fathom	0314080	Cabernet	0314126
Burgundy	0314081	Blue	0314127
Caviar	0314082	Platinum	0314128
		Black	0314129



Model 321 First Call Cover

This cover features tailored, slip-over styling and is reversible end-to-end. Fits cots 76" x 23" (193 cm x 58 cm), which includes the Model 24 series and Model 23 series cots. It is available in the Crypton® Aria or Suede. Includes a 12" x 14" pocket.

Suede	SKU	Aria	SKU
Burgundy	0314087	Cabernet	0314130
Caviar	0314088	Blue	0314131
		Platinum	0314132
		Black	0314133



Model 325 First Call Cover

With elastic on one end, this slipcover fits folding stretchers approximately 74" x 21" (188 cm x 53 cm). It is available in the Crypton® Aria or Suede. Includes a 12" x 14" pocket.

Suede	SKU	Aria	SKU
Fathom	0314068	Cabernet	0314134
Burgundy	0314069	Blue	0314135
Caviar	0314070	Platinum	0314136
		Black	0314137



Model 330 First Call Cover

This cover fits One-Man® cots, most stretchers and standard cots and has a full-length brass zipper. The cover features snap-fastener tabs that hold it in place beneath the mattress and it has full-expansion restraint strap slots. Fits cots approximately 75" x 23" (191 cm x 58 cm). It is available in the Crypton® Aria or Suede. Includes a 12" x 14" pocket.

Suede	SKU	Aria	SKU
Fathom	0314092	Cabernet	0314138
Burgundy	0314093	Blue	0314139
Caviar	0314094	Platinum	0314140
		Black	0314141

Model 335 First Call Pouch

The First Call Pouch comes complete with a bottom and full-length brass zipper. The pouch is secured by snap fastener tabs and features full expansion restraint strap slots. Fits One-Man® cots and stretchers approximately 75" x 23" (191 cm x 58 cm). It is available in the Crypton® Aria or Suede. Includes a 12" x 14" pocket.

Suede	SKU	Aria	SKU
Fathom	0314074	Cabernet	0314142
Burgundy	0314075	Blue	0314143
Caviar	0314076	Platinum	0314144
		Black	0314145



24-MAXX® & 24-MiniMAXX®

First Call Pouch

The First Call Pouch comes complete with a bottom and full-length brass zipper. The pouch is secured by snap fastener tabs and features full expansion restraint strap slots. The pouch also has snaps to expand for larger bodies. Fits One-Man® cots and stretchers approximately 75" x 24" (191 cm x 61 cm). It is only available in the Crypton® Aria fabric. Includes a 12" x 14" pocket.

Product	SKU
24-MAXX & 24-MiniMAXX First Call Pouch, Cabernet	0314156
24-MAXX & 24-MiniMAXX First Call Pouch, Black	0314157
24-MAXX & 24-MiniMAXX First Call Pouch, Blue	0314187
24-MAXX & 24-MiniMAXX First Call Pouch, Platinum	0314188



Crypton® Fabrics

Ferno Covers and Pouches are now made with patented Crypton® Aria and Suede. Every fiber is encapsulated with a stain, odor and bacteria-resistant barrier. The breathable moisture barrier is permanently integrated into the fabric, ensuring a complete and proven performance system from the fibers up. Nothing can penetrate the fibers or the barrier. The Aria and Suede may be spot cleaned or machine washed when excessively soiled.



Model 101-H Hydraulic Operating Table



Product Overview

Allows quick height and angle adjustments using the three foot pedals. Either end of the table may be raised or lowered to any position between 28½" and 40½" above the floor for easy preparation from a standing or sitting position. The table top is convex to drain fluids away from the body and an extra-deep trough runs the perimeter of the table, reducing the need for splash guards. A drain in the center of the foot end quickly eliminates fluids from the table. Four 8" swivel wheels lock instantly with a single foot pedal or one set of wheels locks directionally for easy rolling. Type 304 stainless steel with a 3 finish ensures easy maintenance and a solid surface base eliminates crevices where liquids can accumulate.

Key Features

- Three foot pedals for quick height and angle adjustments
- Convex table top to drain fluids away from body
- Extra-deep trough reduces need for splash guards
- Center drain at foot end to eliminate fluids
- Four wheels lock instantly with a single foot pedal
- 304 stainless steel ensure's ease of maintenance

Product

NSN: 9930-00-164-0648
101-H Hydraulic Operating Table

SKU

0661010

Model 101-H with Side Extension Panels

SPECIFICATIONS

	Length	Width	Height Max.	Height Min.	Wheelbase	Weight	Load Limit
101-H	80" (203 cm)	30" (76 cm)	40½" (103 cm)	28½" (72 cm)	24½" x 48½" (62 x 123 cm)	158 lb (72 kg)	600 lb (272kg)



Four 8" Swivel Wheels lock instantly with a single foot pedal or one set of wheels directionally locks for easy rolling.



Three Foot Pedals provide quick height and angle adjustments.



Multiple Positions at either end from 28½" to 40½" above the floor for easy preparation from a standing or sitting position.



Drain in the center of the foot end quickly eliminates fluids from the table.

Accessories



38-BB Body Bridge
0695790



Side Extension Panel (SEP)

Product

- Side Extension Panels (each)
- Side Extension Storage Bracket
- Side Extension Panel Kit

SKU

- 0695796
- 0695797
- 000SEPKIT



Model 102 Folding Operating Table



Features & Accessories



Adjustable Height



Folds for Storage



38-BB Body Bridge
0695790



Side Extension Panels (SEP)
SEP (each) 0695796

Product Overview

A true combination table, ideal for embalming, dressing and transferring. An exclusive, one-hand release easily adjusts either end of the table from 32½" to 38½" with the ends being independently adjustable. The table is constructed of a stainless steel top with a convex surface, tubular aluminum frame, and 6" wheels with ball bearings. The swivel wheels lock to keep the table stationary while in use. The drain, located in the center of the foot end, quickly eliminates fluid from the table. Folds for storage when not in use and can stand on one end for storage behind a door or in a closet.

Key Features

- Combination table for embalming, dressing and transferring
- Exclusive one-hand release for adjustments
- Stainless steel top
- Folds for storage

Product

Model 102 Folding Operating Table

SKU

0661020

SPECIFICATIONS

	Length	Width	Height Max.	Height Min.	Wheelbase	Weight	Load Limit
Model 102	80" (205 cm)	30" (77 cm)	38¾" (98 cm)	32¾" (83 cm)	64" x 27¼" (163 x 69 cm)	87 lb (39½ kg)	1000 lb (454 kg)

Model 103 Combination Operating Table



Features & Accessories



6" Wheels



38-BB Body Bridge
0695790



Side Extension Panels (SEP)
SEP (each) 0695796
Storage Bracket 0695797
SEP Kit 000SEPKIT

Product Overview

A multipurpose table, ideal for embalming, dressing and transferring. For added convenience, each end can be adjusted independently for individual working height and drainage.

The stainless steel top is durable and rigid, featuring a convex surface and deep side troughs for efficient drainage. Six-inch wheels with locks keep the table stationary while in use.

Key Features

- Multipurpose for embalming, dressing and transferring
- Stainless steel top
- Wheels lock while table is in use

Product

Model 103 Combination Operating Table

SKU

0661030

SPECIFICATIONS

	Length	Width	Height Max.	Height Min.	Wheelbase	Weight	Load Limit
Model 103	80" (205 cm)	30" (77 cm)	37½" (95 cm)	31½" (80 cm)	53" x 27" (136 x 69 cm)	80 lb (36 kg)	1000 lb (454 kg)

Model 34 Folding Dressing Table



Folded

Features & Accessories

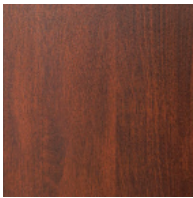

Wood Grain

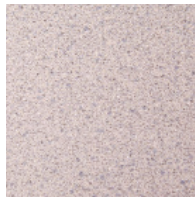

Grey

Product Overview

The Model 34 Dressing Table unfolds quickly for use and stores compactly when not in use. The two-piece, laminated top resists scratches and stains and can be cleaned in seconds. Four 6" swivel wheels are equipped with locks. Please specify grey or wood grain laminated table top when ordering.

Key Features

- Folds for storage
- Easy-to-clean table top
- Six-inch swivel wheels
- Available in grey or wood grain top

Product

- Model 34, Wood Grain Top
- Model 34, Grey Top
- Model 34W, Wood Grain Top
- Model 34W, Grey Top

SKU

- 0663401
- 0663402
- 0663919
- 0663920

The Model 34W includes the same features as the regular width Model 34, but is 29" (74 cm) wide.

SPECIFICATIONS

	Length Open	Length Folded	Width	Height Open/Max.	Folded/Min.	Weight	Load Capacity
Model 34	77" (196 cm)	16" (41 cm)	24½" (62 cm)	34" (86 cm)	59" (150 cm)	68 lb (31 kg)	500 lb (227 kg)

Model 36 Dressing Table



Features & Accessories



Adjustable Height



Height Adjustment at Both Ends



6" Wheels

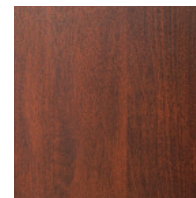

Wood Grain



Grey

Product Overview

An exclusive, one-hand release on the Model 36 allows you to quickly adjust the table height from 32" to 38". The Model 36 rolls on four 6" swivel wheels that lock directionally for stability. Specify grey or wood Grain laminated table top when ordering.

Key Features

- Adjustable Height
- Easy-to-clean table top
- Six-inch swivel wheels
- Available in grey or wood grain top

Product

- Model 36, Wood Grain Top
- Model 36, Grey Top
- Model 36W, Wood Grain Top
- Model 36W, Grey Top

SKU

- 0663601
- 0663602
- 0663923
- 0663924

The Model 36W includes the same features as the regular width Model 36, but is 29" (74 cm) wide.

Specifications

	Length Open	Length Folded	Width	Height Open/Max.	Folded/Min.	Weight	Load Capacity
Model 36	77" (196 cm)	NA NA	24½" (62 cm)	38" (97 cm)	NA NA	77 lb (35 kg)	500 lb (227 kg)

Cemetery Church Truck



Features & Accessories



Folds Compactly



8" Pneumatic Wheels

Product Overview

Made of strong, rectangular aluminum tubing, featuring a protective gloss-anodized finish, keeps the truck looking new and makes it easy to clean. The stable x-frame undercarriage and rubber bumpers help secure the casket. Large, eight-inch pneumatic wheels roll easily over grass or rough terrain. With four swivel wheels allowing for greater maneuverability and two wheel locks. When moved without a casket a special built-in center handle allows the truck to be pushed, pulled or carried. Includes four side handles for lifting over curbs.

The Cemetery Church Truck locks into four positions, allowing a wide range of casket sizes to be displayed with one truck. The additional length increases stability and makes an attractive appearance. Available in silver, bronze, gold, blue-grey or onyx finish.

Not compatible with drape frames or drapes.

Key Features

- Superior craftsmanship to maintain finish and allow for easy cleaning
- Stable x-frame to secure casket
- Suitable for grass or rough terrain
- Locks into four positions to allow for a range of casket sizes

Product

Product	SKU
Cemetery Church Truck (Silver)	0618883
Cemetery Church Truck (Bronze)	0618884
Cemetery Church Truck (Gold)	0618885
Cemetery Church Truck (Blue-Grey)	0618886
Cemetery Church Truck (Onyx)	0618887

Specifications

Length	
Folded	7" (17 cm)
1st Position	19" (49 cm)
2nd Position	30" (75 cm)
3rd Position	50" (128 cm)
Fully Extended	61" (156 cm)
Height	
Folded	33" (83 cm)
Fully Extended	25" (64 cm)
Width	18" (46 cm)
Wheel Size	8" (20 cm)
Weight	59 lb (27 kg)
Maximum Load	1000 lb (454 kg)

Model 87 Church Truck

Made of strong, rectangular aluminum tubing, with a protective gloss-anodized finish that keeps the truck looking new and makes it easy to clean. The stable x-frame undercarriage and rubber bumpers help to secure the casket. Six-inch rubber wheels roll easily over carpet, sills and other obstacles with quiet dignity. When moved without a casket, a special built-in center handle allows the truck to be pushed, pulled or carried. The Model 87 Church Truck locks into four positions, allowing a wide range of casket sizes to be displayed with one truck. The additional length increases stability and makes an attractive appearance. Available in bronze, gold, blue-grey, silver or onyx finish.

Key Features

- Superior craftsmanship to maintain finish and allow for easy cleaning
- Stable x-frame to secure casket
- Six-inch wheels to roll easily over a variety of terrain
- Locks into four positions to allow for a range of casket sizes

Product

Product	SKU
Model 87 Church Truck, Bronze	0618861
Model 87 Church Truck, Gold	0618862
Model 87 Church Truck, Blue-Grey	0618863
Model 87 Church Truck, Silver	0618860
Model 87 Church Truck, Onyx	0618864
Model 87 Church Truck with Handles, Bronze	0618866
Model 87 Church Truck with Handles, Gold	0618867
Model 87 Church Truck with Handles, Blue-Grey	0618868
Model 87 Church Truck with Handles, Silver	0618865
Model 87 Church Truck with Handles, Onyx	0618869



MODEL 87 Specifications

Length	
Folded	6" (16 cm)
1st Position	19" (50 cm)
2nd Position	30" (77 cm)
3rd Position	50" (127 cm)
Fully Extended	61" (155 cm)
Height	
Folded	29" (74 cm)
Fully Extended	22" (56 cm)
Width	18" (46 cm)
Wheel Size	6" (15 cm)
Weight	36 lb (16 kg)
Maximum Load	1000 lb (454 kg)

Model 88 Church Truck

Designed for those who prefer a compact truck, the Model 88 extends to 47" long. The church truck is constructed of the same rectangular, anodized aluminum tubing used on the Model 87 Church Trucks. Features 6" wheels and three locking frame positions. Available in bronze, gold, blue-grey, silver or onyx finish.

Key Features

- Six-inch wheels with three locking frame positions
- Constructed of anodized aluminum tubing
- Extends to 47"

Product

Product	SKU
Model 88 Church Truck, Silver	0618870
Model 88 Church Truck, Bronze	0618871
Model 88 Church Truck, Gold	0618872
Model 88 Church Truck, Blue-Grey	0618873
Model 88 Church Truck, Onyx	0618874
Model 88 Church Truck with Handles, Silver	0618875



MODEL 88 Specifications

Length	
Folded	6" (16 cm)
1st Position	16" (41 cm)
2nd Position	24" (60 cm)
3rd Position	38" (97 cm)
Fully Extended	47" (118 cm)
Height	
Folded	29" (74 cm)
Fully Extended	22" (56 cm)
Width	18" (46 cm)
Wheel Size	6" (15 cm)
Weight	32 lb (14 kg)
Maximum Load	1000 lb (454 kg)



Model 87-F Drape Frame Attachment

The Model 87-F Frame Attachment is a metal lattice frame that attaches to the church truck at six points to provide strong, yet lightweight drape mounting.

Product	SKU
Model 87-F Drape Frame Attachment	0648700

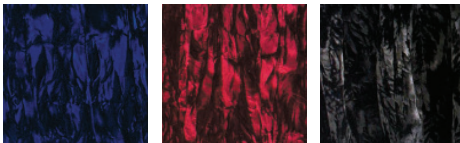

Blue Cardinal Black

Model 87-D Drapes

The Model 87-D Velvet Drapes fit the Model 87 Church Trucks. Available in 3 colors: blue, cardinal, or black crushed velvet.

Product	SKU
Drape 87 – Crushed Velvet (Blue)	0312900
Drape 87 – Crushed Velvet (Cardinal)	0312890
Drape 87 – Crushed Velvet (Black)	0314032



Model 401/402 Church Truck Covers

The Ferno church truck cover allows you to protect your church truck from dust and scratches while in storage. The Model 401 is designed for use on church trucks without drapes. The Model 402 is designed for use on church trucks with drapes. Available in black, cabernet, platinum or blue Crypton® Aria material.

Model 401 dimensions
27.5"L x 21.75"W x 8.25"D
(70 x 55 x 21 cm)

Model 402 dimensions
26"L x 27.75"W x 13.75"D
(66 x 70 x 35 cm)

Product	SKU
401 Church Truck Cover – Aria Cabernet	0314146
401 Church Truck Cover – Aria Blue	0314147
401 Church Truck Cover – Aria Platinum	0314148
401 Church Truck Cover – Aria Black	0314149
402 Church Truck Cover – Aria Cabernet	0314150
402 Church Truck Cover – Aria Blue	0314151
402 Church Truck Cover – Aria Platinum	0314152
402 Church Truck Cover – Aria Black	0314153

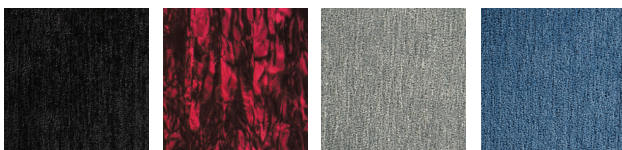

Aria Black Aria Cabernet Aria Platinum Aria Blue

Model 110 Showroom Truck



Product Overview

The Model 110 is a dual-duty truck that works as a showroom and utility truck. The polished aluminum frame is exceptionally strong and will look like new for years with minimal maintenance. Rubber tips hold caskets or rough boxes firmly in place while five-inch ball-bearing wheels roll over obstacles with ease.

Key Features

- Superior craftsmanship to maintain finish and allow for easy cleaning
- Rubber tips hold caskets and boxes in place
- Five-inch ball-bearing wheels easily roll over obstacles

Product

Model 110 Showroom Truck

SKU

0611100

SPECIFICATIONS

	Length	Width	Height	Weight	Load Rating
Model 110	44 ½" (113 cm)	20" (51 cm)	22" (56 cm)	19 lb (9 kg)	600 lb (272 kg)

Model 112 Showroom Truck



Product Overview

The extra-long and wide wheelbase provides exceptional stability and performs equally well as a utility truck. The strong aluminum frame will keep its high polish for years with a minimum of maintenance. Rubber tips hold caskets or rough boxes firmly in place and five-inch, ball-bearing wheels roll over obstacles with ease.

Key Features

- Extra-long, wide wheelbase
- Superior craftsmanship to maintain finish and allow for easy cleaning
- Performs as well as a truck
- Rubber tips hold caskets and boxes in place
- Five-inch ball-bearing wheels easily roll over obstacles

Product

Model 112 Showroom Truck

SKU

0611120

SPECIFICATIONS

	Length	Width	Height	Weight	Load Rating
Model 112	47" (119 cm)	22" (56 cm)	21" (53 cm)	19 lb (9 kg)	1000 lb (454 kg)

Model 124 Adjustable Casket Table

The Model 124 Adjustable Casket Table adjusts to fit various vehicle sizes. By placing bier pins in the appropriate openings, the table will accommodate infant and child caskets as well. Bier pins sold separately.



Product
Casket Table without Bier Pins

SKU
0661224

Model 570 Series Bier Pins

The following Bier Pins are compatible with the Model 156 Roller System.

Product	SKU
Model 575 Bier Pin Storage Plate	0815750
Model 576 Bier Pin Set	0695760
Model 577 Adjustable Bier Pin Set	0695770
Model 577 Stationary Bier Pin	0695780

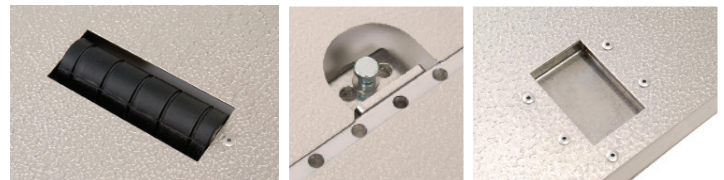

Tailgate Roller Assemblies

Tailgate Roller Assemblies available as single or dual assembly.

Single Roller Assembly
13" x 4" x 2"
(34 cm x 10 cm x 5 cm)

Dual Roller Assembly
24" x 4" x 2"
(60 cm x 10 cm x 5 cm)



Single Roller Assembly

Dual Roller Assembly

Product	SKU
Model 573 Single Roller Assembly	0815730
Model 574 Dual Roller Assembly	0815740

SPECIFICATIONS

	Length Max	Width	Height	Weight	Load Capacity
Model 124	92 ¼" (237 cm)	27 ½" (71 cm)	2" (5 cm)	28 lb (12.7 kg)	1000 lb (454 kg)

Ferno Makes it Easy to Place Your Order

To locate the nearest distributor or sales representative in your area: Call +1-877-733-0911 or FAX +1-888-388-1349. A Customer Relations Representative will ensure that your requirements are met.

Terms of Sale

Government-Funded Agencies will be granted "Net 30 Day" Open Accounts by providing the following information:

1. Name of government agency
2. Telephone and FAX numbers
3. Billing address (must be domestic location)
4. Shipping address
5. List of authorized purchasers (if restricted)
6. Purchase Order number requirements

Payment may also be made using Federal SmartPay Credit Cards, which will be charged at the time your order is shipped.

Freight Policy/Shipping

All orders will be shipped by the most efficient and cost-effective ground transportation (UPS, DHL, truck, or USPS). Orders are shipped F.O.B. Wilmington, Ohio. Shipping charges are prepaid and will be added to the invoice. Airfreight or other special shipping arrangements can be made at the customer's request. Special shipping charges are prepaid and will be added to the invoice. Special-order and out-of-stock items will be back ordered and shipped as soon as possible; the customer will be notified of back orders. Partial orders will be shipped unless the customer provides other instructions. Additional shipping charges may apply to oversized items

Returning Merchandise

Ferno Group, Inc. reserves the right to refuse any unauthorized return shipment. Buyer must obtain a RMA (Return Material Authorization) number from Ferno Group Inc. prior to return. Ferno Group Inc. reserves the right to charge a 20% restocking fee on all return shipments.

Damaged Goods Claims

All claims for merchandise that is damaged during transit must be made by the customer directly to the carrier within 10 days of receipt of goods. Please save all boxes and packing material until you have filed your claim.

Disclaimers

Latex Content: Ferno relies on product information received from manufacturers and can accept no liability for misinformation or for changes in product content. Ferno strongly recommends that customers read all product labels for latex content information

before using the products. Product Changes: Ferno reserves the right to change product specifications, price, and availability without notice.

Limited Warranty

For 70 years funeral home professionals have relied on Ferno products because Ferno stands behind its products. Ferno Group Inc. warrants all mortuary equipment (see limited warranty below) to be free from defects in material and workmanship for a full two years, the longest in the industry. Under this limited warranty, Ferno will repair, replace or refund the purchase price of any Ferno piece of equipment as Ferno deems appropriate.

Ferno mortuary products are warranted to be free from defects in material and workmanship for a period of one year, except as follows:

- External finishes (gelcoat, paint, powder coat, decals, etc.) are warranted for 90 days.
- Soft goods (webbing, vinyl, fabric, foam, etc.) are warranted for 90 days.
- Mortuary products (except for hydraulic parts and soft goods) are warranted for 2 years.

Ferno repairs are warranted for 90 days from the date of repair. This limited warranty applies only when you use and care for the product as described in the instructions provided with the product. Improper use and care may void this warranty. The warranty period begins the date the product was first purchased by you as the original end-user or the date you as the original end-user receive it if you have proof of the delivery date. The limited warranty is not transferable or assignable in any manner. Shipping charges are not covered by this limited warranty. Ferno is not liable for shipping damages or damages sustained through using the product.

Non-Ferno products sold by Ferno retain the product manufacturer's original warranties and guarantees. Such warranties and guarantees, if any, are solely those of the product manufacturer. Ferno offers no warranties or guarantees of any kind additional to those of the product manufacturer, nor does Ferno assume any liability for products manufactured by others.

Limitation of Liability

If a product is proven defective, Ferno will repair or replace it, or, at its option, refund the item's purchase price. In no event is Ferno liable for more than the selling price of the product. The purchaser accepts these terms in lieu of all damages. Except for the limited warranty above, Ferno makes no other warranties, either expressed or implied. Ferno makes no implied warranties of merchantability and fitness for a particular purpose for its own product or for the products of others. In no event will Ferno be liable for any indirect or consequential damages sustained in connection with the delivery, use, or performance of its products. Under breach of limited warranty, any legal action for breach of the limited warranty must be

filed within one year of the date the breach occurs or should have been discovered.

Limited Warranty Claims and Disputes

Contact Ferno Customer Service promptly if you receive a product from Ferno that you suspect is defective. A representative will assist you with the claim procedure. Before sending any product to Ferno, obtain a return authorization number from Ferno Customer Service.

Support

If at any time you require additional information, need technical specifications, have repair or maintenance questions or need any other information about our products, contact our Technical Support Department by calling +1-800-733-3766 or by emailing us at support@ferno.com. We have knowledgeable, dedicated Technical Support staff available to assist you regarding any question that you may have about your Ferno product.

Service

Ferno provides a number of service options to mortuary customers to aid in maintaining their Ferno products. Preventive maintenance, maintenance service and repair service is available nationwide through authorized service providers. Skilled technicians operating from service centers across the country will come right to your location.

Maintenance

In addition to providing repair services, Ferno authorized service partners also provide preventive maintenance services for Ferno products. Prepaid preventive maintenance contracts are available that include biannual or quarterly cleanings, complete inspections and preventive maintenance checks and service all for one low fee.

A full list of authorized service providers can be found at:

www.ferno.com/service-and-support/sub-corp/support

Call us at +1-800-733-3766 or email info@ferno.com for more information and a quote for your service.

Index

C		M	
Church Trucks		Mattresses	
Cemetery Church Truck	26	24-MAXX® Cot Mattress	12
Model 87 Church Truck	27	24-MiniMAXX® Cot Mattress	12
Model 88 Church Truck	27	Model 372 Cot Mattress	12
		Model 375 Tapered Cot Mattress	12
Cots		O	
iNX Integrated Power Cot & Load System	4	Operating Tables	
24-MiniMAXX® Mortuary Cot	6	Model 101-H Hydraulic Operating Table	20
24-MAXX Mortuary Cot	7	Model 102 Folding Operating Table	22
Model 24 Multi-Level Cot	8	Model 103 Combination Operating Table	23
Model 27-1 Multi-Level Cot	9		
Model 23 Roll-In Style Cot	10	P	
Mini Cot Roll-In Style Cot	11	Pouches	
Covers		Model 338 Disaster Pouch	17
24-MAXX® First Call Cover	18	Model 347-1 Disposable Pouch	17
Model 320 First Call Cover	18	24-MAXX® First Call Pouch	19
Model 321 First Call Cover	18	24-MiniMAXX® First Call Pouch	19
Model 325 First Call Cover	18	Model 335 First Call Pouch	19
Model 330 First Call Cover	18		
Model 401/402 Church Truck Covers	28	R	
D		Restraints	
Drape Frame Accessories		Model 414-OL Over-The-Lap-Restraints	13
Model 87-F Drape Frame Attachment	28	Model 414-R Wrist Restraints – Cot Sidearm	13
Model 87-D Drape	28	Model 415-AR Ankle Restraints	13
		Model 430 Two-Piece Restraints	13
Dressing Tables		Rollers	
Model 34 Folding Dressing Table	24	Model 124 Adjustable Casket Table	31
Model 36 Dressing Table	25	Model 570 Series Bier Pins	31
		Tailgate Roller Assemblies	31
F		S	
Fasteners		Scoop™ Stretcher	
Model 5 Mortuary Fastener	14	Model 65 Scoop™ Stretcher	15
Model 533 Wheel Cups	14	Model 65 EXL Scoop™ Stretcher	15
Model 534/535 Post Cups	14	Scoop EXL TSL Extenders	15
L		Showroom Trucks	
Lifting Aids		Model 110 Showroom Truck	29
Model 132 Manta™ Retrieval Aid	14	Model 112 Showroom Truck	30
Beasy Trans™ Transfer Board	15		
Ferno Transfer Board	15	Stretchers	
		Model 11 Stretcher with Wheels	16
		Model 131 Flexible Stretcher	17
		Model 135 Stretcher/Body Bag	17



**FOR MORE INFORMATION, CONTACT YOUR LOCAL
FERNO DEALER.**

T +1.800.733.3766
F +1.937.382.6569
INFO@FERNO.COM

70 WEIL WAY
WILMINGTON, OHIO 45177
USA

WWW.FERNO.COM/MORTUARY

FOR HEROES. FOR LIFE.